



***KANBAN THE WAY YOU
NEED IT***

FRS Flexible Roller Carrier System



KANBAN THE WAY YOU NEED IT – WITH THE FLEXIBLE ROLLER CARRIER SYSTEM FRS

Kanban has established itself as a method of process control in many areas. Based on the pull principle, the process is oriented to the actual consumption of materials at the point of supply and consumption. It is based on self-controlling control loops and helps to significantly reduce inventories of intermediate products.

MiniTec enables you to implement Kanban at the assembly workstation using various systems. The FRS (Flexible Roller Carrier System) is a particularly variable solution. This is a modular system for the implementation of MiniTec designs for material supply via rollers.

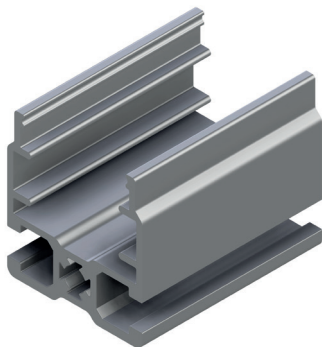

Profile 45 FRS
20.1152/0

ONE FITS ALL: THE PROFILE 45 FRS

The basis is the special MiniTec profile 45 FRS, which is compatible with the standard MiniTec profile series. It has a holding device for different types of rollers. Accordingly, you can configure the material supply at the workplace individually according to your requirements - and adapt or convert it at any time should your needs change!

FOR EACH TASK THE RIGHT ROLE

Suitable roller inserts are available for large and heavy materials as well as for smaller transport goods. If there is a risk of lateral slippage, rollers with side guides are available. If materials are also to be moved sideways, there is a special ball caster element. Complete roller strips are available for bridging longer distances - this saves you having to string together individual roller elements. All roller inserts are suitable for ESD applications (there is a choice of roller strips).

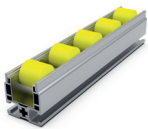

Roller strip with
cylindrical rollers
32.0550/0



Roller strip ESD with
cylindrical rollers
32.0555/0

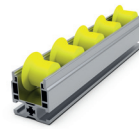

Roller strip with
flanged rollers
32.0560/0



Roller strip ESD with
flanged rollers
32.0565/0

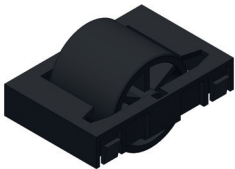

Roller element
50 D28-Z-FRS
32.0683/0

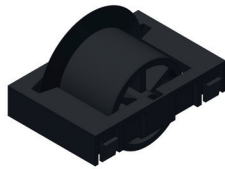

Roller element
50 D28-S-FRS
32.0684/0

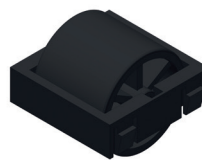

Roller element
33 D28-Z-FRS
32.0685/0

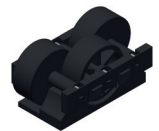

Roller element
50 D26-3R-FRS
32.0686/0



Roller element
50 D9-5R-FRS
32.0688/0

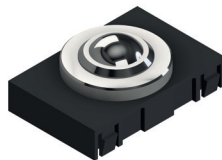

Ball caster element
50-D16-FRS
32.0689/0

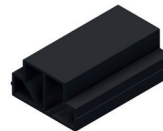

Slide profil - FRS
32.0691/0

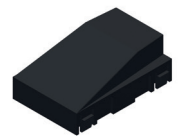

Adapter-FRS
32.0692/0

KEY FEATURES

- Compatible with the standard profile series
- Individual material provision at the workplace
- Roller inserts for any kind of transport goods
- Extensive range of accessories

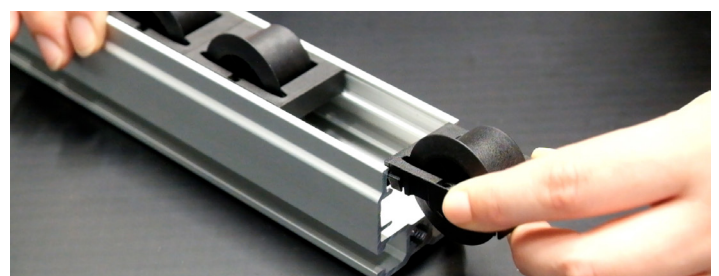



PRODUCTS

SUITABLE ACCESSORIES FOR YOUR INDIVIDUAL SYSTEM

To match the wide range of roll types, FRS also offers a comprehensive range of accessories - from covers to protect against contamination to transition pieces for height compensation and backstops. As you can see, it has never been so easy to implement Kanban in your assembly. We will be happy to answer any questions you may have regarding the appropriate composition of your FRS system!

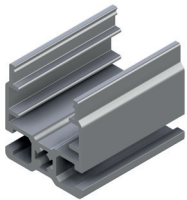

Profil 45 FRS
20.1152/0



Angle bracket 45 FRS-3°
32.0662/0



Mounting bracket with
stop 45 FRS-3°
32.0663/0



Fixing shoe FRS
32.0668/0



End piece-10-FRS
32.0687/0



Spacer with stop short FRS
32.0693/0

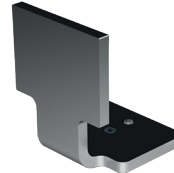

Spacer with stop long FRS
32.0694/0

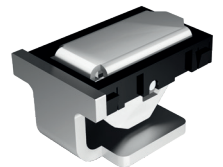

Return stop 50-FRS
32.0690/0



End cap 45 FRS
22.1187/0



Cover 45 FRS - G
32.0661/2



Cover 45 FRS-Z
32.0661/1



Cover 45 FRS-S
32.0661/0

ADVICE

When assembling the castors and slide profiles, please note that they have different heights. You can find all details on this as well as possibilities to compensate for differences in an overview as a PDF here for download: <https://www.minitec.de/en/products/workplace-systems/kanban-systems>



MiniTec Facts & figures

THE ART OF SIMPLICITY

MiniTec has continuously developed from a specialist for miniature guides to a leading technology company and special equipment manufacturer

Today 400 experts at 11 locations in Germany, France, USA, United Kingdom, Spain, Slovenia and China develop tailor-made solutions for our customers. At the same time, more than 60 partners worldwide ensure reliable service and competent technical support.

Our solutions are just as individual as our customers' requirements. As a full-service manufacturer, we use our design system to implement intelligent systems and special machines for a wide variety of tasks in all important industrial sectors: from automotive, chemicals and electrical engineering to energy supply, aerospace, mechanical engineering, the metal and pharmaceutical industries.

 **1986**
Founded

 **420**
Employees
280 in Germany

 **60**
Sales and service partners
around the world

 **Business award**
„Innovativer Mittelstand“
Award
„Attraktiver Arbeitgeber
Rheinland-Pfalz“
Honorary award
of the region Westpfalz

 **11**
Locations
Germany, France, Slovenia,
United Kingdom, Spain, USA,
China



MiniTec-partners worldwide

Australia | Austria | Belgium | Bosnia and Herzegovina | Brazil | Bulgaria | Canada | China | Croatia
Czech Republic | Estonia | Finland | France | Greece | Hungary | India | Italy | Latvia | Liechtenstein
Lithuania | Luxembourg | Malaysia | Mexico | Montenegro | Netherlands | New Zealand | Northmacedonia
Poland | Portugal | Romania | Russia | Serbia | Singapore | Slovakia | Slovenia | South Africa | Spain
Sweden | Switzerland | Turkey | Ukraine | United Kingdom | USA | Vietnam